



USER MANUAL

URS500 AND URS600 SERIES

MODELS

URS500 URS600

URS500EP2 URS600EP2



URS500 / URS600



URS500EP2 / URS600EP2

UNI-RAM CORPORATION • ONTARIO • CANADA

Revision 2019-07

CONTENTS

INTRODUCTION	3
SAFETY APPROVALS, CAUTIONS AND WARNINGS	3
FEATURES AND SPECIFICATIONS	4
SAFETY FEATURES	4
PREPARATION AND SETUP	5
LOCATION AND CONNECTION	5-6
SOLVENT REQUIREMENTS AND DEFINITIONS	6
SOLVENT TRANSFER (EP2 MODELS)	6-7
OPERATING PROCEDURES	8-11
SYSTEM SPECIFICATIONS	12
THEORY OF OPERATION	13
TROUBLESHOOTING GUIDE	14-14
ERROR CODES	16-17
SERVICE PROCEDURES	19-20
REPLACEMENT PARTS	20
WARRANTY	21

INTRODUCTION

Uni-ram holds many patents on designs used in its innovative products. Every machine is tested for compliance with Quality Assurance standards. Follow the instructions on preparation, use and operation to operate this machine safely and effectively. Ensure that this manual is readily available to the operator at all times. If you have any questions about the operation of this machine, contact:

North America:
Uni-ram Technical Service
1-800-417- 9133
Other Continents:
Contact Your Supplier

SAFETY APPROVALS

This unit is certified under UL standards U2208 and CSA standards C22.2 No. 30 and No. 88 by ETL for use in non-hazardous locations as well as for use in hazardous locations Class 1, Division 1, Group D – T2C and and Class 1, Division 2, Group D -T2C.



CAUTIONS AND WARNINGS

- The operator should wear protective clothing in accordance with local safety and environmental regulations, with a minimum of face goggles and gloves along with an apron and respirator if required.
- Always disconnect the power source before performing maintenance.
- DO NOT SMOKE OR USE THIS EQUIPMENT NEAR A POTENTIAL SOURCE OF IGNITION SUCH AS SPARKS OR AN OPEN FLAME. This unit must be located at least 6 feet (1.8 m) from all potential sources of ignition including electrical receptacles, switches, pilot lights, fixtures and contacts when installed in a non - hazardous locations.
- The ambient temperature must be between 5°C (41°F) to 35°C (95°F).
- DO NOT RECYCLE NITROCELLULOSE WHICH IS EXTREMELY VOLATILE. IT AUTOMATICALLY IGNITES AT 135°C TO 166°C (275°F TO 330°F). Do not install, operate or maintain this equipment where the auto ignition temperature of the solvent is lower than 250°C (482°F).
- Do not install, operate or maintain this equipment where the auto ignition temperature of the hazardous atmosphere(s) is lower than 250°C (482°F).
- Solvents that are recycled can be flammable. Establish and follow safe practices to store and handle solvents.
- Units must be installed by a qualified electrician and according to applicable laws.

SERIAL NUMBER

The serial number of this unit is located on the back of the unit in a black and silver label. The serial number should be recorded and filed in a safe place for future reference regarding quality and/or safety issues.

FEATURES AND SPECIFICATIONS

All Uni-ram Solvent Recyclers feature **rapid-start** direct electric heating of solvent (so there is no diathermic oil to change) as well as high-efficiency condensers, air cooled with a motor driven fan. All of the Recyclers can be used with any Uni-ram Automatic Apray Gun Cleaner. The “E” models are designed to be linked directly to a Uni-ram “E” series Automatic Spray Gun Cleaner or to an external container. The direct connection creates a self-contained Recycling System allowing Timer-controlled Transfer In and Out between the Solvent Recycler and the other component.

MODEL	URS500	URS600	URS500EP2	URS600EP2
VOLTAGE(V)	110/120	220/240	110/120	220/240
CURRENT USAGE (A)	13.3	6.7	13.3	6.7
RECOMMENDED CIRCUIT AMPS	20	15	20	15
EXPLOSION PROOF PLUG / RECEPTACLE	5-20P / 5-20R	6-20P / 6-20R	5-20P / 5-20R	6-20P / 6-20R
TANK CAPACITY	5 US GAL (20L)	5 US GAL (20L)	5 US GAL (20L)	5 US GAL (20L)
CONDENSER AND FITTING	COPPER	COPPER	COPPER	COPPER
LID GASKET	NEOPRENE**	NEOPRENE**	NEOPRENE**	NEOPRENE**
SOLVENT TRANSFER SYSTEM	NO	NO	YES	YES
DIMENSIONS (WDH")	19 X 19 X 45	20 X 20 X 45	19 X 19 X 45	20 X 20 X 45
WEIGHT (LB/KG)	130/59	130/59	140/64	140/64
** ALSO AVAILABLE IN VITON OR TEFLON				

Safety Features:

- **Certified** to UL standards U2208 and CSA standards C22.2 No. 30 and No. 88 by ETL. Approved for use in non hazardous locations as well as approved for use in hazardous locations Class 1, Division 1, Group D and Class 1, Division 2, Group D.
- **Explosion proof construction** and intrinsically safe electric circuitry.
- **Computer controlled** with many built-in safety programs including temperature control of all critical points including tank, condenser and fan motor. Power is cut when the temperature at any of these points rises above a pre-set level. Operation also terminates when other abnormal conditions exist (eg: boiling does not start on time or the distillation process takes too long).
- **Automatic pressure relief** lid system prevents pressure in the Distillation Tank from exceeding 0.5 to 1.0 psi. (0.035 to 0.070 kg/cm²).
- **Self Diagnostic** error messages are displayed on the Display Panel.
- **Dual lid** cover system.
- **Compact, enclosed cabinet** for safe storage of the Solvent Receiving Container inside the cabinet.

Operating Features:

- **Rapid-start** due to direct electric heating of solvent, no diathermic oil to change.
- **Short cool-down time.** High efficiency condenser, air cooled with motor driven fan.

Warranty: 1 year on unit, 2 years on pump.

PREPARATION AND SETUP

- Carefully inspect the shipping carton for any sign of transport damage.
- Carefully remove the unit from the shipping carton.
- Check the unit for damage. **Report any transport damage immediately to the carrier and your vendor. Initiate a freight claim with the carrier.** The manufacturer is not responsible for freight damage.
- A Liner Bag and Retainer Ring are already installed inside the distillation tank.
- Check the Accessory Kit for the parts listed below. If any parts are missing, contact your supplier. Additional consumables and accessories are also listed.
- Level the unit using the adjustable feet and install the Door Handle.
- For models with the Solvent Transfer System (EP2 Models), install the Solvent Transfer Hoses and the Air Supply Kit. (See instructions on Pages 7-8).

ACCESSORY KIT (Included Parts)

All Models	Replacement Part Number
Manual	NA
Lid Gasket, Standard (Neoprene)*	770-2150N
Liner Bag, 2 Spares	See below for re-order numbers
Door Handle & 2 Screws	120-318 & 909-404S
Solvent Outlet Tube	770-8131
EP2 Models Only	
Transfer Hoses and Fittings (EP2 Series)	KIT-TRANSHOSES-A
Air supply Kit (EP2 Series)	KIT-AIRSUPPLY-E

CAUTION:

USE ONLY GENUINE UNI-RAM LINER BAGS WHICH ARE 2 MIL THICK, LIGHT BLUE IN COLOUR WITH A SAWTOOTH EDGE AND A 3/16" WELD.

THEY ARE SPECIALLY MANUFACTURED TO BE STRONG, HEAT RESISTANT AND CHEMICAL RESISTANT.

USE OF A NON-UNI-RAM LINER BAG MAY VOID THE WARRANTY.

LOCATION AND CONNECTION

This unit is certified for use in non-hazardous locations and hazardous locations Class 1, Division 1 Group D and Class 1, Division 2, Group D.

- **Non-hazardous Location:**
The unit must be located outside of a hazardous location. We recommend that the unit be located at least 6 feet from any potential source of ignition such as electrical receptacles, switches, pilot lights, fixtures, contacts and similar equipment. To clarify the definition of an appropriate location, contact your local authority. Use the explosion proof plug and receptacle shown in the Chart under FEATURES AND SPECIFICATIONS. The explosion proof plug is provided with the unit. The customer is responsible for acquiring the matching explosion proof receptacle. The power cord is connected to the power

supply only by a qualified electrician in accordance with the National Electrical Code.

- **Hazardous Location:**

In hazardous locations (Class 1, Division 1, Group D and Class 1, Division 2, Group D), use the explosion proof plug and receptacle shown in the Chart under FEATURES AND SPECIFICATIONS. The explosion proof plug is provided with the unit. The customer is responsible for acquiring the matching explosion proof receptacle. The power cord must be connected to the main power supply by a qualified electrician, in accordance with the National Electrical Code.

Select a location that meets EACH AND EVERY requirement, as follows ...

LOCATION AND CONNECTION (continued)

- 1) Comply with the instructions in the section, CAUTIONS AND WARNINGS, page 3.
- 2) Position the solvent recycler in a location so that there is at least 6 inches (15 cm) of space all around the unit. Ensure that the safety lid and door freely opens fully and a container for receiving the distilled solvent can freely move in and out of the cabinet. The unit must be in a location where people or equipment cannot disturb the cable or connection. The cord must be connected directly to the main power supply; an extension cord cannot be used.
- 3) Connect the unit to a dedicated 15 A branch circuit.

Power Requirements: URS500/ URS500S/ series: 110/ 120 volts AC, 13.3 A
URS600/ URS600S/ series: 220/ 240 volts AC, 6.7 A

“READY (L)” and / or “READY (H)” LED Light on the Control Panel comes on when power is supplied to the unit

SOLVENT REQUIREMENTS

This unit recycles flammable solvents and combustible solvents. Flammable liquids include lacquer thinner, paint thinner, acetone and other paint diluents. Flammable Solvents have a flash point below 38.7°C (100°F). These solvents are commonly used in the industry as a cleaning solvent, or as a paint diluent.

Dirty solvent to be distilled must meet **each requirement** described below. The MSDS, material solvent data sheet, provides data on the properties of the pure, clean solvent.

- 1) The BP (Boiling Point) of the dirty solvent must be less than 200°C (392°F). BP increases with greater contamination.

Note: Recycle recently contaminated solvent only. Standing solvent can become acidic over time.

- 2) The auto-ignition temperature of the solvent to be distilled must be higher than 260°C (500°F) for safe operation. Do not recycle Nitrocellulose. The auto ignition temperature is 135°C (275°F).

Note: Do not recycle both paint diluent and parts washer solvent in the same unit. When paint diluent or lacquer thinner is contaminated with parts washer solvent “FISH EYE” problems may result.

Waste Residue

The waste residue of some paints will remain moist after recycling due to the composition of the paint itself. A dry waste residue is not guaranteed.

Definitions

Flash Point: The lowest temperature at which the vapor of a solvent can be made to ignite in air.

Auto-ignition temperature: the temperature at which solvent ignites by itself.

INSTALLATION OF SOLVENT TRANSFER HOSES AND THE AIR SUPPLY KIT (EP2 MODELS ONLY)

- 1) Transferring Solvent To and From a Spray Gun Cleaner
- 2) Transferring Solvent To and From a Drum / Container
- 3) Stand-alone Operation

For the URS500 and URS600 (Non-EP2) Models, use 3) Stand-alone Operation

1) Transferring Solvent To and From a Spray Gun Cleaner

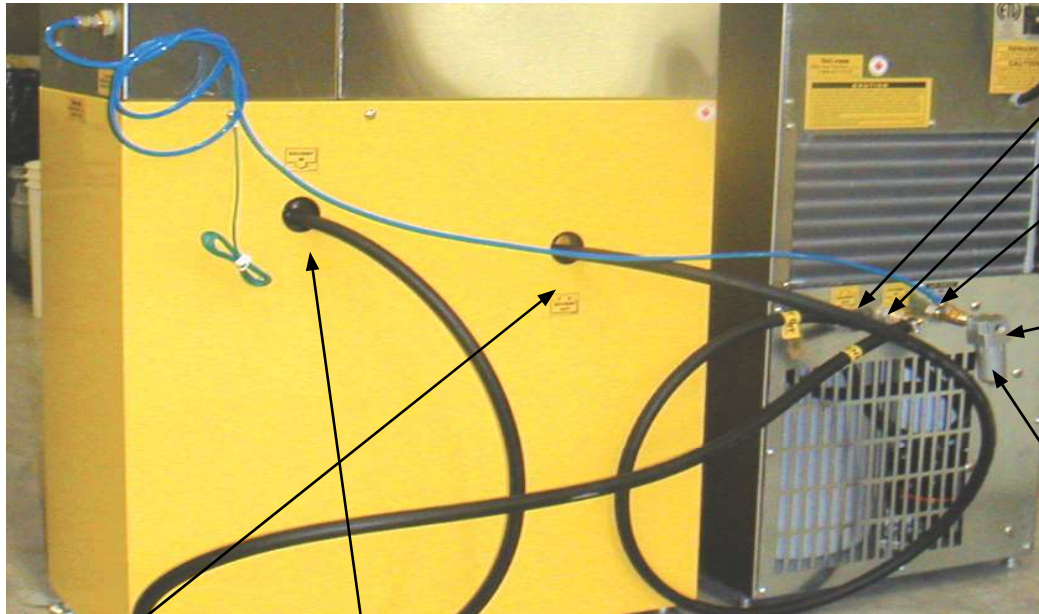

Dirty Solvent In
 Clean Solvent Out
 Blue Airline - Attach to Tee and Gun Cleaner
 Air Supply Input, Requires Fitting (not supplied)
 Attach Moisture Filter (optional) to Air Input and the Tee to the Filter (if used) and the Blue Airline to Tee and Gun Cleaner. The Air Supply fitting is also not supplied.

Dirty Solvent Out

Clean Solvent In



SOLVENT PAILS
 Inside Gun Cleaner Cabinet

Hoses:

Connect the end of the hose with the "Solvent In" label to the "Solvent In" port on the recycler. Hand tighten. Pass the other end of this hose through the hole in the back of the gun cleaner that is marked "Solvent Out" and hand tighten onto the lid of the "WASH SOLVENT" pail. Connect the hose with the "Solvent Out" label to the "Solvent Out" port at the back of the recycler and pass the other end of this hose through the hole in the gun cleaner that is marked "Solvent In" and hand tighten onto the lid of the "CLEAN SOLVENT" pail. Make sure there is no leakage.

Air Supply:

The blue airline and Tee are for use with an "E" series spray gun cleaner to allow one air supply to feed both the spray gun cleaner and the solvent recycler. **Ensure the air supply is not connected to the spray gun cleaner or solvent recycler before installation.**

Remove the 2 airline connectors from the "T" . Connect the male port of the "T" to Air Inlet of the recycler. Connect the Moisture Filter (optional). Connect one end of the blue airline to the "T". Connect the other end of the blue air line to the Air Input of the spray gun cleaner.

2) Transferring Solvent To and From a Drum / Container



Attach Air Supply fitting (not supplied) and/or Moisture Filter (not supplied)

Connect the end of the hose with the “Solvent In” label to the “Solvent In” port on the recycler. Hand tighten. Connect the other end of the hose to the 3 ft suction pipe using the hose clamp. Insert the 3 ft suction pipe into the drum / container of dirty solvent. Connect the other hose with the 4 3/8” suction pipe to the “Solvent Out” port on the recycler and place the suction pipe into a clean drum / container large enough to receive the clean, recycled solvent.

Air Supply:

The blue airline and Tee are for use with an “E” series spray gun cleaner to allow one air supply to feed both the spray gun cleaner and the solvent recycler. It is not used in this situation. If necessary, connect a Moisture Filter (not supplied) directly to the Air Input port of the Solvent Recycler and attach a suitable Air Supply Fitting (not supplied).

2) Stand-alone Operation

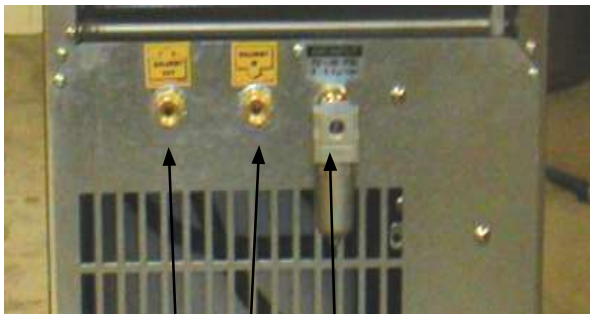

Not Used for Stand-Alone Operation, no connections are necessary

OPERATING PROCEDURES

Wear protective clothing in accordance with local safety and environmental regulations. Use face goggles and gloves as a minimum. Use an apron and respirator if required.

Summary of Operating Steps:

- 1) Open the Tank Lid and Safety Cover
- 2) Transfer Solvent to the Recycler Tank
- 3) Position Solvent Receiving Pail
- 4) Change temperature set point, as required
- 5) Start recycling
- 6) Finish Recycling
- 7) Transfer clean solvent
- 8) Remove debris
- 9) Clean Distillation Tank and Lid Surface
- 10) Install new liner bag
- 11) Inspect Lid Gasket, Remove and Replace if necessary

Each Step is described in detail below.

1) Open the Tank Lid and Safety Cover

- Open the safety cover.
- Open the inner lid by releasing the Lid Clamp.
- Make sure that Tank is empty and that a Liner Bag is properly installed in the Tank.

PULL UP TO OPEN. PUSH DOWN TO LOCK

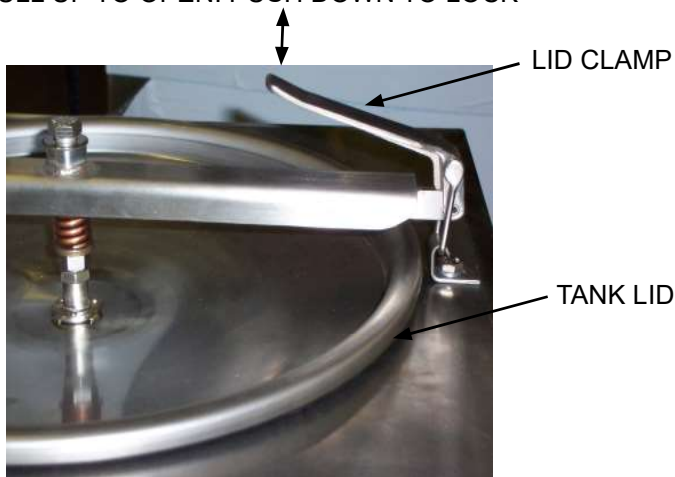

2) Transfer Solvent TO the Recycler Tank

Verify that the solvent to be recycled complies with the requirements described in the section, Solvent Requirements. Solvent can be put into the Distillation Tank by hand or by using the Transfer Hoses and built-in Transfer System (EP2 Models only).

a) For models without the Solvent Transfer System

Pour the solvent into the Distillation Tank. Fill to 1.5 inches below the Retainer Ring.

Maximum volume is 5 gal (20 L) and minimum volume is 1.5 gal (6 L). Do not let the container of dirty solvent touch the top of the recycler. When pouring the contaminated solvent, make sure all solvent goes into the Liner Bag, not between the Liner Bag and Distillation Tank. Clean Lid Gasket and top of distillation tank. Close inner lid, engage lid clamp and close safety lid. **Caution:** Do not overfill Distillation Tank because contaminated solvent could flow into Condenser and block the condenser passage way. Close the Tank Lid, lock down the Lid Clamp and close the safety Cover.

b) For models with the Solvent Transfer System (EP2 Models):

- Open the Transfer Valve by turning the handle counter-clockwise 90°.
- Turn the Filling Timer knob clockwise fully. Dirty solvent will flow from the Transfer Port into the Liner Bag and stop when the timer runs out.
- Close the Transfer Valve by turning the handle clockwise 90°.
- Close the tank Lid, lock down the Lid Clamp and close the safety Cover.

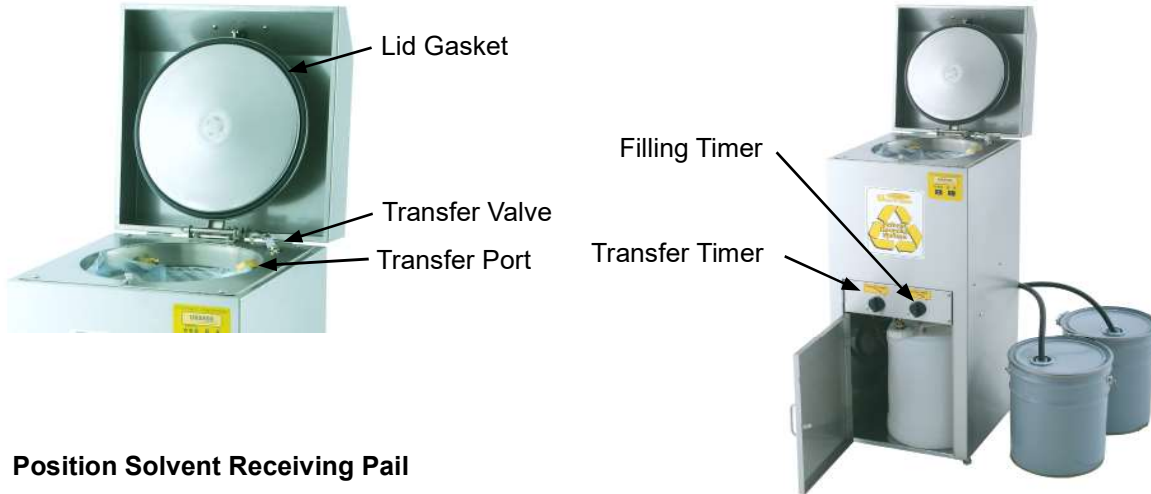
**3) Position Solvent Receiving Pail****a) For models without the Solvent Transfer System**

Open the Door and position a Solvent Receiving Pail (not provided) with a minimum size of 5 US Gal (20 L) inside the cabinet. Insert the Solvent Outlet Tube (short and curved) into the top opening of the pail. The Solvent Outlet Tube must extend below the rim of the pail to prevent solvent spillage. If the pail is metal, connect the alligator clamp of the Ground wire to the rim of the pail. Close the door.

b) For models with the Solvent Transfer System (EP2 Models):

Open the Door. A special, connected, plastic Solvent Receiving Pail is provided. Check to make sure that:

- the Solvent Outlet Tube is inserted into the hole in the top of the pail
- the Cap with the Pick Up Tube is tightly attached to the pail
- the Grounding Clamp (alligator type) is attached to the metal Pick Up Tube hose fitting.

4) Change temperature set point, as required. If the Temperature Set Point is satisfactory, skip this section.**Conditions to consider before starting Setup:****Minimize Temperature Set Point**

After recycling there will be a small amount of solvent, about 1/8 US gal (500 ml), remaining in the distillation tank due to condensation. Select the lowest Temperature Set Point that recycles the solvent to this level.

Estimate Boiling Point

Add 45°C (113°F) to the boiling point of the pure solvent as shown on the MSDS (Material Safety Data Sheet) or another reliable source.

Recycle more often

The boiling point of the waste solvent mixture increases as it gets dirtier. To reduce the boiling point, recycle more often.

The display for the Control Panel is located at the top right corner of the base cabinet.

The LEDs for READY(L) and READY(H) on the control panel indicate the Temperature Set Point.

To Change the Temperature Set Point:

Make sure the “HEAT” and “FAN” lights are off. Press and hold the “OFF” button while pressing the “ON” button repeatedly to cycle through the 6 possible Set Points. If you go past the desired Set Point, continue to press the “ON” button until you cycle back to the missed Set Point.

TEMPERATURE SET POINTS	READY LIGHTS		
	L	M	H
90°C (194°F)	*		
115°C (239°F)	*	*	
140°C (284°F)		*	
165°C (329°F)		*	*
190°C (374°F)			*
200°C (392°F)	*	*	*

The Temperature Set Point is pre-set at the factory to 200°C (392°F) - all 3 lights are on.

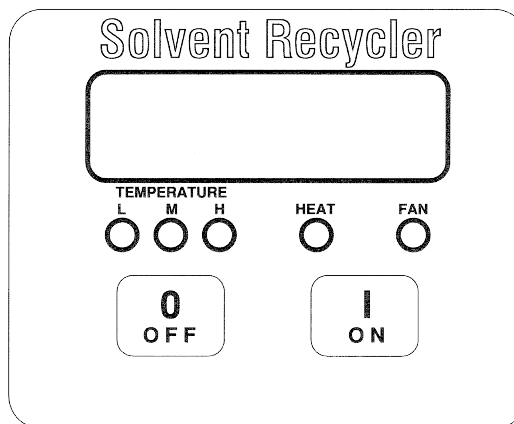

KEYPAD (CONTROL PANEL)

5) Start Recycling

Press “ON” button. Distillation starts, “HEAT” and “FAN” lights come on. If you want to stop recycling press “OFF”.

6) Finish Recycling CAUTION: DO NOT OPEN LID UNTIL COOLING IS COMPLETE

The clean recycled solvent is available for use when the heat lamp goes off. Recycling is complete and the unit is ready for the next operation when “HEAT” and “FAN” lights are off. Temperature set point indicators - READY (L) and /or READY(H) lights are on but not flashing.

7) Transfer Clean Solvent

a) For models without the Solvent Transfer System: remove the pail and replace with an empty one.

b) For models with the Solvent Transfer System: turn the Transfer Timer knob clockwise fully. The clean solvent will flow out of the Solvent Receiving Pail into either a free-standing, external container or the Clean Solvent Pail of a Spray Gun Cleaner. The transfer will stop when the timer runs out.

8) Remove Debris:

Remove the Retainer Ring.

Slowly pull the Liner Bag containing the debris out of the distillation tank in a way that the Liner Bag does not break.

Dispose of the debris in accordance with local regulations.

NOTE: If the bag sticks to the bottom of the tank, turn the recycler on for 5 minutes to loosen the bag from the bottom of the tank, then lift the bag out while the bag is warm.

9) Clean Distillation Tank and Lid Surface

Distillation Tank:

Wipe and dry tank with a cloth.

Remove any remaining debris from the Distillation Tank using if necessary, plastic or wooden tools. Do not clean with abrasive or hard metal instruments that can damage the tank. The warranty does not cover such damage.

Note: There will be about 1/8 Gal (500 ml) of solvent remaining in the Distillation Tank after recycling due to condensation. This solvent, if left in the tank, can cause corrosion. Dirt and debris left in the tank can prevent full heat from reaching the dirty solvent during recycling.

Caution: Acidic or chlorinated solvents typically cause corrosion on an aluminum tank. It appears as black pitting spots on the tank. Excessive pitting leads to an unsafe condition of holes in the walls of the tank and solvent leakage. Inspect your tank after each batch. If there is excessive pitting, call a Service Technician and replace the tank with a corrosive resistant, stainless steel one.

Lid Surface:

Use a cloth. Dry and clean the lid and the top of tank where the Lid Gasket sits to extend the life of the Lid Gasket and prevent leakage. Avoid rotating the lid during cleaning. The lid gasket is a wear item.

10) Install new Liner Bag

Lift Recycler Safety Cover and Tank Lid fully; lids will stay in the open position.

- a) Install the Liner Bag so that the bottom of the Bag sits flat on the bottom of the Distillation Tank as shown.
- b) With thumb and index finger, squeeze the Retainer Ring and insert into inside of the Liner Bag. Let go and make sure it fits securely in the groove.
- d) Fold the flap of the liner bag over the retainer ring so the flap is between the retainer ring and the wall of the distillation tank. **Caution: Ensure that the bag material does not block the Vapor Outlet.**

Do not reuse a liner bag. Use a new liner bag after each recycling for effective removal of waste.

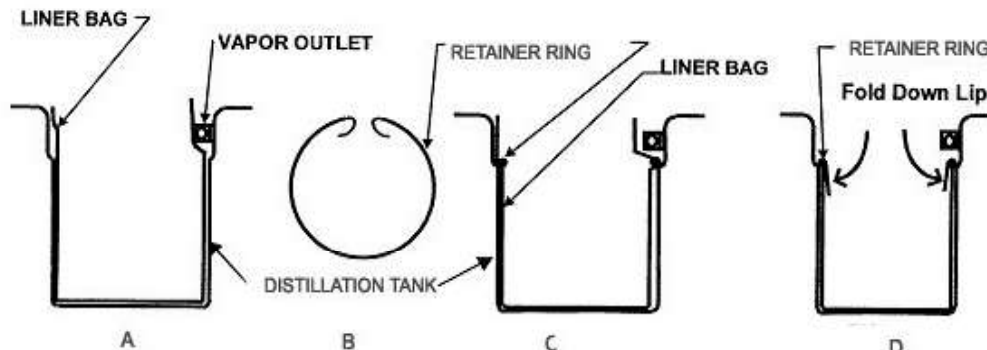

NOTE: This is a schematic drawing only; not all components are exactly as shown.

11) Inspect Lid Gasket, Remove and Replace if necessary as required

Inspect the Lid Gasket for shrinking, hardness and cuts. The Lid Gasket is a wear item as it is exposed to high temperature and solvent vapor during distillation. Damage to the lid gasket will cause solvent to leak.

To remove, open the Safety Cover and Tank Lid. Lift out the old gasket by hand and clean the cavity with a cloth. To Install, place the new gasket in the cavity, rub solvent or soapy water on the gasket to make insertion easier. Press the gasket firmly into the cavity all around.

Note: Keep a spare in stock. One extra is included with the unit.

THEORY OF OPERATION - DISTILLATION PROCESS

Waste solvent consists of the original solvent plus liquid and solid materials picked up during use of the solvent. Recycling separates the original solvent from the waste materials. During the recycling process, the distillation tank fills with dirty solvent and the heating element heats the mixture. The solvent mixture boils and the vapour passes through a cooling condenser where purified, clean solvent, ready for use condenses out. Waste materials in the dirty solvent boil at a temperature substantially above the Temperature Set Point so they remain in the distillation tank for disposal.

Solvent Recycling

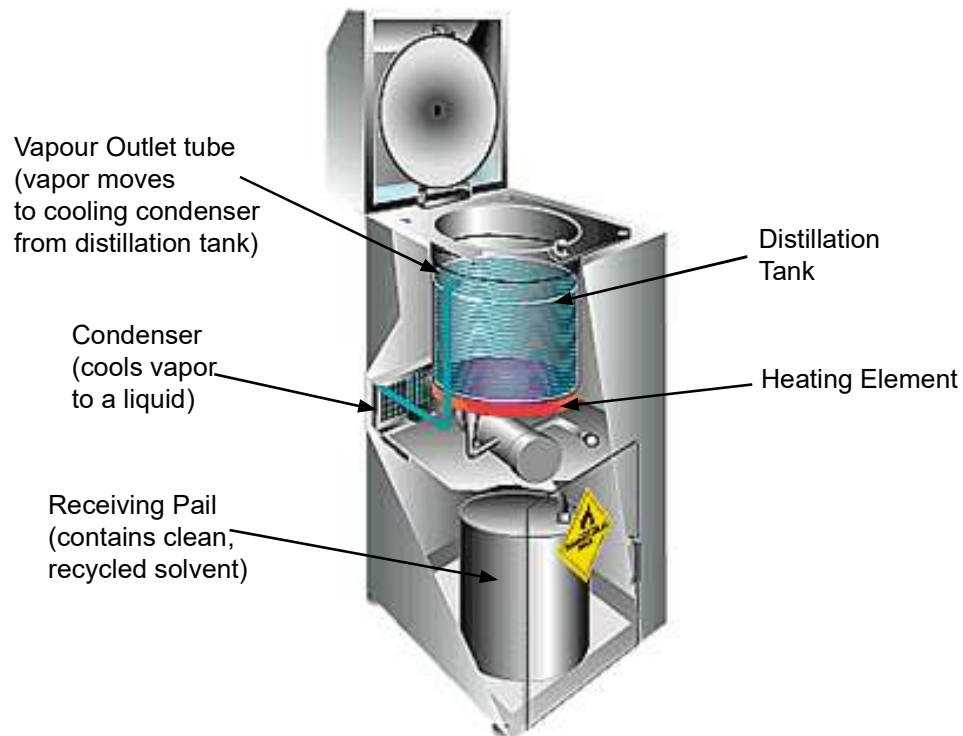

1. Maintenance

WARNING

Remove the power supply or switch off the main switch before all maintenance and service work.

Please note! Only use original spare parts for maintenance and repairs.

Ensure that the warning stickers present and the lights on the URS500 are clearly visible at all times so that they can alert the URS500 users to safe use.

Please note! Never repair the URS500 yourself, use a recognized expert for this. Please contact your supplier. If returning your URS500 device for repair, the boiler must be empty, otherwise your repair cannot be processed.

1.1. Periodic maintenance

Before each use:

- Keep the area around the URS500 clean and free of debris.
- Check the outside and inside of the URS500 for visible damage. Do not turn on the URS500 if you have detected any damage.
- Check the lid gasket for damage. A damaged lid gasket leads to poor sealing and vapour leakage, which is dangerous and wasteful.
- Inspect the cooling air outlet and inlet and ensure that there is sufficient space for unobstructed ventilation. Vacuum clean, if necessary.
- Check the tank for residue and remove it.
- Wipe the top edge of the tank before closing the lid and make sure it is free from paint and contaminated solvent.

Every month:

- Inspect the power cable for wear and damage. If replacement is necessary, the replacement should be carried out by a competent installer for explosion proof equipment.
- Clean the condenser: refer to section 4.2 'cleaning the condenser'.
- Clean the cap of the condenser block. Refer to section 4.4 'Cleaning the condenser discharge tube' .

Every 3 months:

- Run two recycling processes with 5 gallons of clean solvent to keep the condenser discharge tube and the condenser clean.

Every 6 months:

- Replace the lid gasket preventively.

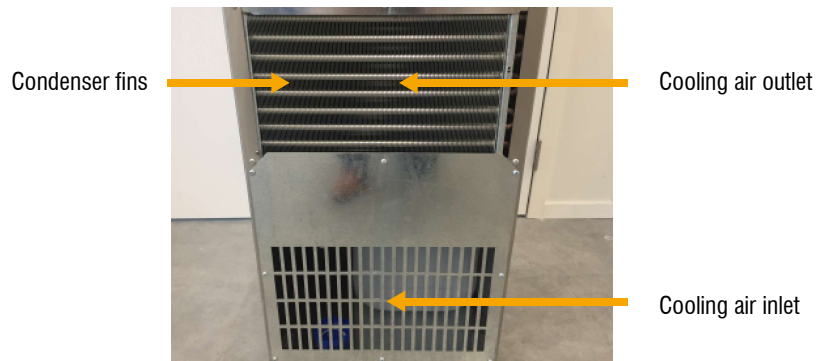

1.2. Cleaning the condenser

The condenser must be regularly checked and cleaned to ensure that it is free of dust and waste. Dust and waste that has collected on the other side of the condenser is not visible in the URS500. If the condenser overheats due to excessive dust, the process will stop and the LEDs will give the fault code 23 or 24. See section 4.6 "Error codes" of this manual for instructions when these errors are indicated.

To clean the condenser, the dust can be blown away with an air gun, or by using a vacuum cleaner with a brush attachment.

1.3. Replacing the lid gasket

Please note! Always use original lid gaskets in the URS500.

To replace the lid gasket, follow these steps:

1. Open the safety cover and the tank lid.

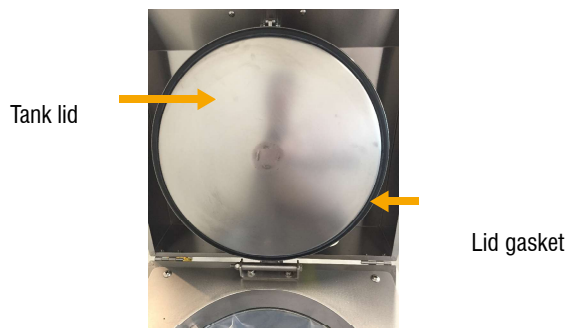

Figure 2. Tank lid of the URS500

2. Hold the lid open with one hand and remove the damaged lid gasket using a flat screwdriver.
3. Clean the edge of the lid where the lid gasket was with a scuff / abrasive material (non-woven), so that all contamination is removed before the new lid gasket is introduced.

1. Install the new lid gasket by hand, by gradually pressing the ring all the way around with your fingers. It is important that the ring is placed flat and no deformations are visible. This can be checked by the horizontal seam on the ring, which must be straight along its entire length. Do not use tools or sharp objects while installing the new lid gasket as they may damage the gasket.

You have replaced the lid gasket.

2. In order to check the proper functioning of the lid gasket, it is advised to recycle the tank once with ± 10 litres of clean water.

1.1. Cleaning the condenser discharge tube

A blockage in the condenser discharge tube can cause solvent to leak out of the URS500.

1. Open the cap of the condenser block. This can be loosened by hand. If this doesn't work, carefully use a water pump pliers.

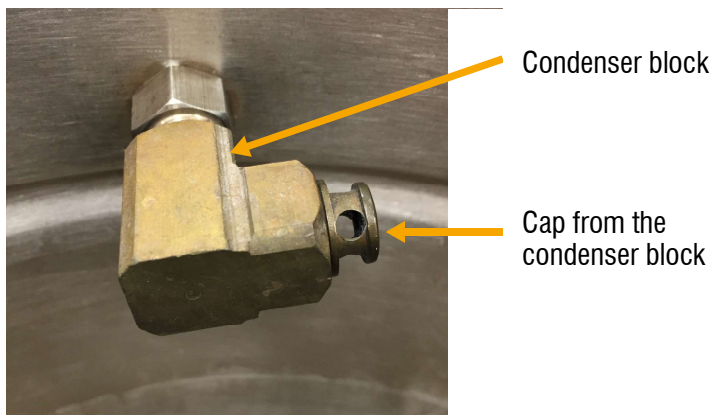

Figure 1. The condenser block with cap

2. Check the condenser discharge tube and the opening of the vapour outlet for visible signs of blockage.

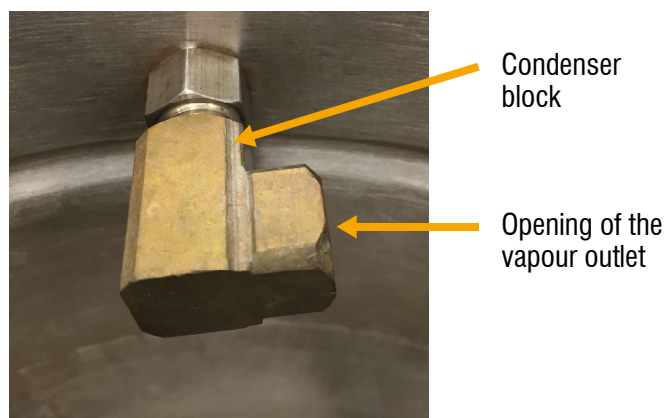

Figure 2. The condenser block

1. Clean the cap of the condenser block. It is important that all openings in the cap are free. If a layer of lacquer / residue is blocking the openings, remove it with a small drill, or allow the cap to soak in thinner and then scrape the dirt off with a metal pin.



Figure 1. Cap from the condenser block

2. If the blockage is not in one of these places, then the condenser is probably blocked.
3. Place a cloth over the inlet port located in the tank. The **outlet** tube is located inside the door above the receiving pail. With a blow gun, blow air through the outlet port. Material in the condenser, if any, will exit the inlet port in the tank.

TROUBLE SHOOTING GUIDE

Carry out each action step until a solution is found. If the recommended actions do not solve the problem call Uni-ram Service in North America or contact a qualified Service Technician.

Caution: Disconnect the power supply before conducting maintenance or service.

PROBLEM	CAUSE	ACTION STEPS
Unit is plugged in, all the lights on the Panel are Off.	Power is not getting to the unit.	Reset breaker or replace fuse. If power is still not getting to the unit, call a Qualified Service Technician. Ensure that the unit is the only device on a circuit with sufficient capacity.
Unit is plugged in, "READY(L)" / "READY(H)" lights are On, Heat light fails to come on when "ON" button is pressed.	Power board or fuse not functioning.	Call Uni-ram Service
Recycled solvent is not clear	1) The solvent is reacting chemically.	1) Lower Temperature Set Point following Operating Procedure 4.
	2) The solvent flow path is dirty. One cause is overfilling the distillation tank.	2) To clean the path, follow Service Procedure 2 and then recycle 3 gal of clean solvent.
	3) Orange colour due to rust in receiving pail.	3) Place a jar under outlet tube and capture some solvent. If the solvent is clear, replace the pail with a non-corrosive one.
	4) Milky colour due to presence of water.	4) Eliminate source of water in solvent.
Dirty solvent remains in Distillation Tank after recycling Note: 1/8 Gal (500 ml) of recycled solvent is expected due to condensation.	1) Poor heat transfer due to dirt and debris left in the tank.	1) Clean the tank, replace the Liner Bag, recycle with pure solvent to test. If successful, the problem is due to a dirty tank, debris left in the tank or the solvent is too contaminated. Adjust accordingly. Follow Operating Procedures closely. If the level of contamination is too high, recycle more often.
	2) Boiling point of solvent is above Temperature Set Point.	2) Raise the Temperature Set Point and repeat the recycling operation. The Temperature Set Point should be the BP of pure solvent (as determined from the MSDS or other source) plus 45°C (113°F) to allow for contamination. If the boiling point is above the maximum Temperature Set Point for your model (200°C), dirty solvent cannot be recycled in this unit.
Liner Bag sticks		Turn unit on for 5 minutes and lift out bag while it is still warm.

PROBLEM	CAUSE	ACTION STEPS
Solvent vapor leaks from the Lid Gasket	1) Lid Gasket has excessive wear as indicated by cracks, shrinkage, hardness etc	1) Replace the Lid Gasket (See Operating Procedure 11).
	2) Solvent flow path is blocked.	2) Follow Service Procedure 2.
	3) Lid Tension not adequate	3) Follow Service Procedure 4.
	3) The Lid is not seated correctly.	3) Follow Service Procedure 5.
	4) The temperature SET-PT too high, resulting in excessively high solvent vapour pressure	4) Reduce the Temperature Set Point and repeat the recycling operation. If successful, continue to recycle using the lower Temperature Set Point.
Sections on Bag are brown and thin due to High Temperature	1) Use of inferior low temperature bag.	1) Use new genuine Uni-ram high temperature Liner Bag and recycle.
	2) Temperature Set Point is too high.	2) Reduce the Temperature Set Point and repeat the recycling operation. If successful, continue to recycle using the lower Temperature Set Point.
The computer appears to be operating erratically.	The computer may require re-booting.	Disconnect the power supply for 30 seconds. Restore power and operate unit.
Residue (puck) in Tank is too wet.	1) Not enough heat to vapourize the solvent.	1) Raise the Temperature Set Point
	2) Residue cannot be dried completely due to its composition.	2) None.

ERROR CONDITION CODES

The computer constantly monitors the unit as it operates.

AN ERROR CONDITION IS INDICATED BY FLASHING "READY" LIGHTS.

NOTE: On later models of the URS500, due to a change in software, the heater light will flash during normal operation. For all error conditions except for an error code "22" condition, the Heater light would be off.

To determine the error type, count the flashes of READY (L) before READY (H) flashes, then count the number of flashes for READY (H). For example, two flashes from READY (L) and then one by READY (H) indicates error code 21. Look up the Error Code on the Chart below. Press the "OFF" button to stop the error code and press the "ON" button to resume operation after the error condition has been corrected. **If the error persists, call for service.**

ERROR CODE	Flashing LED Lights		Description	Action Required
	READY (L)	READY (H)		
11	1 TIME	1 TIME	Open circuit - defective tank thermocouple	Contact Uni-Ram Service
12	1 TIME	2 TIMES	Open circuit - defective condenser thermocouple	Contact Uni-Ram Service
13	1 TIME	3 TIMES	Computer malfunction	Replace computer circuit board
21	2 TIMES	1 TIME	Open Heater Circuit - defective component; heater element, thermostat, wire conductor, blown fuse. A defective thermostat or wire terminal is the most likely cause.	Contact Uni-Ram Service
22	2 TIMES	2 TIMES	Defective heater triac; Heater is still "ON"	Disconnect the power supply immediately. Contact Uni-Ram Service
23	2 TIMES	3 TIMES	Condenser is overheating or thermostat is faulty.	Clean dirty Condenser following Service Procedure 1. If Thermostat is faulty contact Uni-ram Service
24	2 TIMES	4 TIMES	If code 23 condition lasts over 10 minutes, this code will show and operation is terminated.	1) Clean dirty Condenser. See Service Procedure 1. 2) Position the unit to provide 6 inches (15cm) all around the unit. 3) Check Cooling Fan or Fan Motor.
31	3 TIMES	1 TIME	a) Boiling did not occur within 45 minutes. Tank is either empty or there is excessive debris in liner bag or tank is dirty.	a) Clean Distillation Tank following Operating Procedure 7, replace liner bag, following Operating Procedure 9.
			b) Set point is too low.	b) Increase temperature set point following Operating Procedure 4 and recycle with virgin solvent
			c) Boiling point of solvent is above maximum set point.	c) Solvent cannot be recycled.

ERROR CODE	Flashing LED Lights		Description	Action Required
	READY (L)	READY (H)		
32	3 TIMES	2 TIMES	Micro Controller has been reset due to power interruption or drop in voltage during the recycling operation.	Press "OFF" and then "ON" buttons to resume operation. Disconnect power at the source for about 30 seconds. Usually nothing is wrong with the unit.
33	3 TIMES	3 TIMES	a) Recycling did not finish in 6 hours due to power interruption or excessive debris in Liner Bag	a) Clean Distillation Tank following Operating Procedure 7, replace Liner Bag, following Operating Procedure 9,
			b) Temperature Set Point is too low for the solvent.	b) increase Temperature Set Point following Operating Procedure 4 and recycle with virgin solvent
			c) Boiling point of solvent is above maximum set point.	c) Solvent cannot be recycled.

SERVICE PROCEDURES

1) CLEAN CONDENSER

Using a brush attachment, vacuum the condenser at the back of the unit.

2) CLEAR BLOCKED SOLVENT FLOW PATH

CAUTION: WEAR SAFETY GOGGLES.

A blockage in the solvent flow path (Vapour Outlet - Condenser - Solvent Outlet Tube) can cause solvent to leak. To determine the location of the blockage, first check the Solvent Outlet Tube and the Vapour Outlet Fitting for visible signs of blockage or damage. If the problem is not in either of these locations, the Condenser is probably blocked. To clear the condenser, pour some clean solvent into the Vapour Outlet and check if it comes out of the Solvent Outlet Tube. If the blockage persists, blow air at about 30 PSI (2 kg/cm²) into the Vapour Outlet. If the air comes out of the Solvent Outlet Tube, the blockage has been cleared. If not, call for service.

3) REPLACE FUSES

Fuses are located on the Power Control Board inside the Motor Housing.

- Disconnect power supply.
- Remove the Guard Screen by unscrewing two metal screws to get access to the Motor Housing

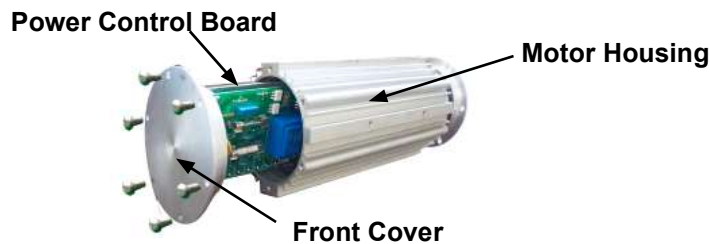

- Unscrew the 6 screws from the Front Cover and pull it gently from the motor housing to expose the fuses. **Note: Care should be taken not to pull the Front Cover too far as some wires may disconnect.**
- There are two fuses for URS500 series and four fuses for URS600 series.

URS500 series:

Fuses F1: 250 V 20.0 A 314 (Fast type) for Heater

Fuses F2: 250 V 2.0 A 312 (Slow type) for Fan Motor

URS600 Series:

There are two each of F1 and F2 fuses.

- Remove the fuses from the board and, using a meter, test each one and replace as needed.
- Carefully push the Power Control Board back into the Motor Housing.
- Ensure that the wire to the computer board is secure.
- Re-install the Front Cover using all 6 screws..
- Install the Guard Screen using two metal screws.
- Close the Door and re-connect the power supply.

4) INCREASE LID TENSION (BY ADJUSTING SPRING BOLT)

CAUTION:

SHOULD BE DONE ONLY AS A LAST RESORT - FIRST CHECK FOR A WORN LID GASKET, A BLOCKAGE IN THE SOLVENT FLOW PATH, LOOSE HINGE OR CROSS BAR BOLTS OR A SET POINT THAT IS TOO HIGH FOR THE SOLVENT BEING RECYCLED.

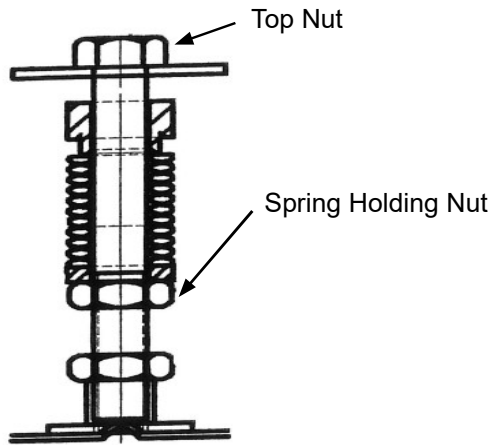

Spring Bolt Assembly

This procedure tightens the Lid by increasing the tension on the spring attached to the Lid Bar Spring Bolt Assembly. The Lid and Bolt Assembly is carefully designed as a Safety Pressure Relief system to prevent a dangerous build up of pressure inside the closed tank. **Do not adjust the Spring Holding Nut by more than 2 full turns maximum.** If 2 full turns do not solve the problem, call for service.

- While holding the top nut with a wrench, turn the nut below the spring no more than a 1/2 turn at a time. Turn in a counter-clockwise direction (as you look down on it).
- After each 1/2 turn, operate the unit normally and check for leaks.

5) REPOSITION LID and TIGHTEN HINGE AND CROSS BAR BOLTS

The Hinge bolts can loosen over time, causing the lid to shift off center. This can lead to an inadequate seal and leaking around the Gasket. Loosen the bolts, reposition the lid and re-tighten the bolts.

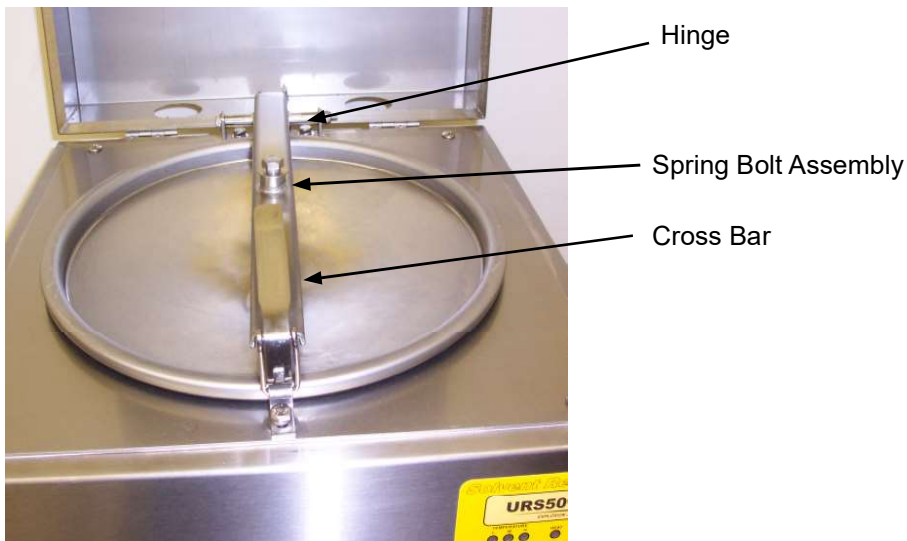

6) RECOMMENDED 6-MONTH MAINTENANCE

- Vacuum the condenser (see Service Procedure 1).
- Clean the solvent flow path by recycling 3 Gal of clean solvent.
- Inspect Distillation Tank for debris, pitting and/or other damage.
- Inspect Lid Gasket for wear or damage (see Operating Procedure 11).

REPLACEMENT PARTS

DESCRIPTION	PART NO.
SAFETY COVER	770-3311
DIAPHRAGM PUMP	UDP4TA
DOOR HANDLE & 2 SCREWS	120-318F & 99-404S
TRANSFER HOSE KIT (E MODELS ONLY)	KIT-TRANSHOSES-A
AIR SUPPLY KIT (E MODELS ONLY)	KIT-AIRSUPPLY-E
LID GASKET, NEOPRENE	770-2150N
SOLVENT RECEIVING PAIL	750-710C
TIMER WITH KNOB	115-200/K
LINER BAG. PKG OF 10	LB900C-10
RETAINER RING	770-9110

Full Product Warranty

These Uni-ram products have been engineered and manufactured to high performance standards. Each unit has been subjected to detailed factory testing before shipment.

This product comes with a one-year full warranty from the date of purchase. Uni-ram Corporation reserves the right to repair or replace the unit, free of charge, to the original purchaser if a part is found to be defective in material or workmanship as determined by factory service personnel. The items listed below under "Conditions of Warranty" as consumables are not covered.

Uni-ram reserves the right to direct the customer to ship the unit collect to the Uni-ram factory or to an approved Service Center for repair using the Uni-ram Return Goods Procedure or to repair the unit on-site. To prevent damage in transport, the purchaser must ship the unit in the original packaging or use alternate adequate packaging. All units must be shipped clean and free of solvent.

Conditions of Warranty:

As Uni-ram Corporation has no control over the working conditions or circumstances under which the purchaser stores, handles or uses the product, Uni-ram makes no warranty or claim, either expressed or implied with respect to this product's fitness for any purpose or the result to be obtained from its use. This condition applies to the sale of all products and no representative or distributor of Uni-ram Corporation has the authority to waive or change these conditions.

This warranty applies only to the original purchaser and does not apply if the unit has been misused, overloaded, neglected, altered or used for any purpose other than those specified in the operating and installation instructions. Deterioration due to normal wear is not covered by this warranty. Damage due to accident, transportation, fire, floods or acts of God is also not covered. Units whose serial numbers have been altered or removed are not covered. The warranty is invalid if unauthorized abrasives are used in this unit. Unauthorized attempts at self-repair or alterations by the owner also invalidate this warranty. Interior or exterior finishes are not covered by this warranty.

Consumable Items are not covered by this warranty.

This warranty replaces all other warranties expressed or implied by statute or otherwise.

To make a claim, call Uni-ram Service at 1-800-417-9133 and quote the serial number of the unit.

USE ONLY GENUINE UNI-RAM LINER BAGS WHICH ARE 2 MIL THICK, LIGHT BLUE IN COLOUR WITH A SAWTOOTH EDGE AND A 3/16" WELD.

THEY ARE SPECIALLY MANUFACTURED TO BE STRONG, HEAT RESISTANT AND CHEMICAL RESISTANT.

USE OF A NON-UNI-RAM LINER BAG MAY VOID THE WARRANTY.